

TDS
Technical Data Sheet

Release Date
10 2023



MDL System is a series of individual desks and multiple desks in linear and facing configurations, as well as meeting tables in various shapes, sizes, and finishes. The metal support structure consists of tracks below the worktop and contoured legs in extruded aluminium. A special fastening system permits the various elements to be positioned along the tracks as required, for maximum flexibility.

The MDL Full version features a special C-shaped profile that forms an original auxiliary shelf, as well as a handy space to insert small drawers and optional power and data connections. Available accessories include a cable tray, an auxiliary table, and a drawer pedestal on castors.

In the MDL Basic Plus version, the desktop is equipped with an L-shaped auxiliary shelf. The desktop is available in various sizes and finishes, including wood and high-performance laminate, all with elegantly bevelled edges.

MDL System is completed by a series of meeting tables with robust metal structures and elegant tops in wood or laminate with bevelled edges. The tables can be equipped with cable management components positioned below the top and accessed through hatches installed flush with the work surface.

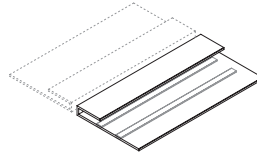
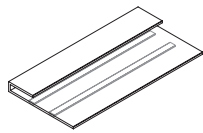
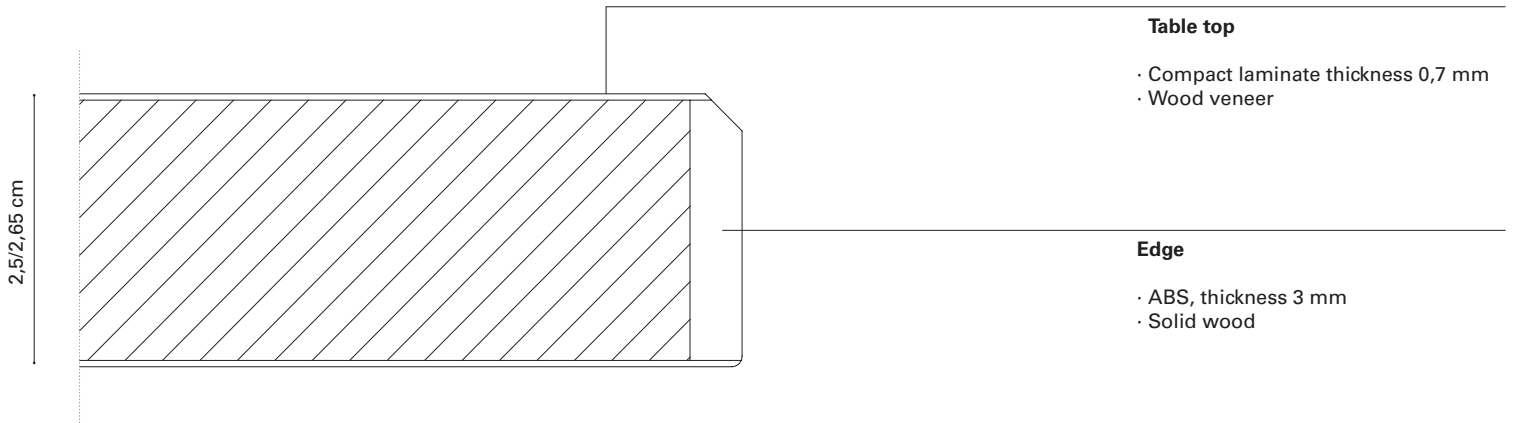

MDL FULL TABLE TOPS

Full single table top

180x90xH12 cm
G DL PI 180 90A ..

210x90xH12 cm
G DL PI 210 90A ..

Full double table top

180x90xH12 cm
G DL PI 180 90AD ..

210x90xH12 cm
G DL PI 210 90AD ..

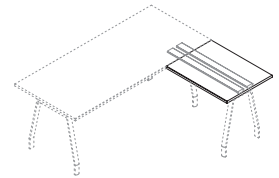
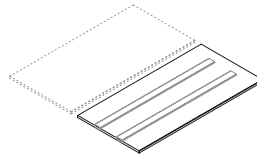
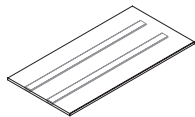

MDL BASIC TABLE TOPS

**Table top for single workstation
depth 80 cm**

160x80xH2,6 cm
G DL PI 160 80 ..

180x80xH2,6 cm
G DL PI 180 80 ..

210x80xH2,6 cm
G DL PI 210 80 ..

**Table top for double workstation
depth 80 cm**

160x80xH2,6 cm
G DL PI 160 80 D ..

180x80xH2,6 cm
G DL PI 180 80 D ..

210x80xH2,6 cm
G DL PI 210 80 D ..

Return for rectangular table top

80x60xH2,6 cm
G DL PI 080 60 L ..

100x60xH2,6 cm
G DL PI 100 60 L ..

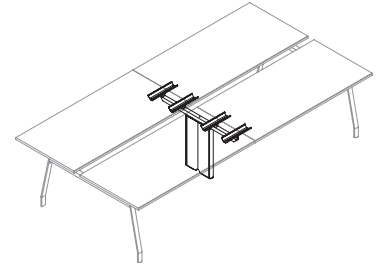

LEGS

Leg for single workstation

Leg for double workstation

Height-fixed center leg/cable riser for double workstations

64x5xH71 cm
G DL GA 64 ..

136x5xH71 cm
G DL GA 136 D ..

48,7x50xH71 cm
G DL GD F ..

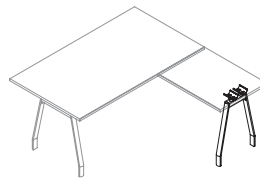
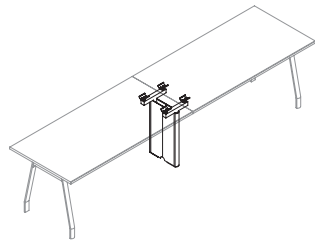

Height-fixed center leg/cable riser for linear workstations

Leg for lateral return

48,7x50xH71 cm
G DL GS F ..

48x5xH71 cm
G DL GA 48 L ..

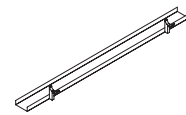
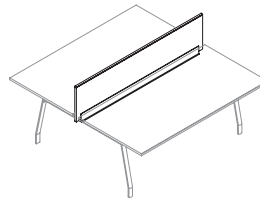

ACCESSORIES

L-shaped shelf

Screen

Cable tray

160x26xH16 cm
G DL ME 160 ..

160x2,4xH36 cm
G DL SC 160 36 ..

100x20xH3 cm
G DL WB 100 ..

160x26xH16 cm
G DL ME 180 ..

180x2,4xH36 cm
G DL SC 180 36 ..

125x20xH3 cm
G DL WB 125 ..

160x26xH16 cm
G DL ME 210 ..

210x2,4xH36 cm
G DL SC 210 36 ..

150x20xH3 cm
G DL WB 150 ..

200x20xH3 cm
G DL WB 200 ..

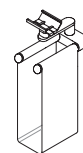
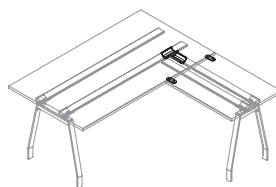
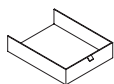

ACCESSORIES

Polycarbonate tray for Full table top
Only for Full tops

24,5x30,5xH6,9 cm
G DL CS 25 ..

Connecting kit for orthogonal table tops
Only Platinum Grey

12x8,6xH4 cm
G DL DG ..

CPU holder
Only Shadow Grey

30x14/17xH36/53 cm
G DL A UNI ..

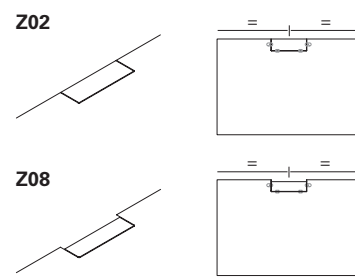
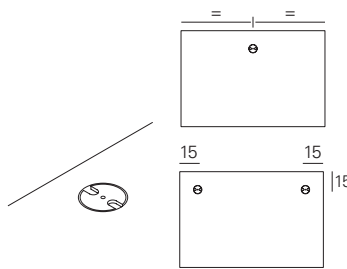
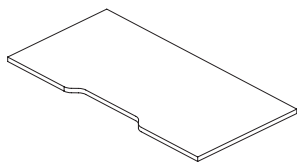

FLIP ACCESS DOOR
TOP ACCESS

Cable entry slots
For all table tops

53,5x6,5xH3 cm
TS2 SP 53 6A ..

Top access
Only chromed.
Specify the position

7x7xH3 cm
D DS 271 9 ..

Flip access door
Same top finish.
Specify the position

30x12xH3 cm
I SP 030 10 Z02 ..

30x8xH3 cm
I SP 030 10 Z08 ..

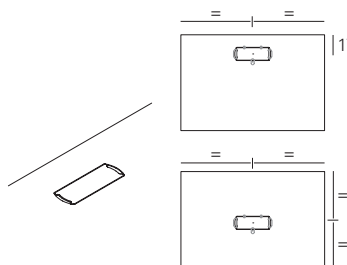
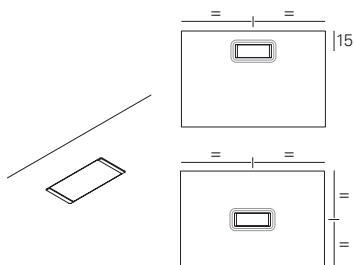

Rectangular flip access door
Same top finish,
only for laminate tops.
Specify the position

30x11xH3 cm
P D P CAB Z24 ..

Rectangular flip access door
Same top finish,
only for laminate and veneer tops.
Specify the position

30x11xH3 cm
P D P CAB Z11 ..

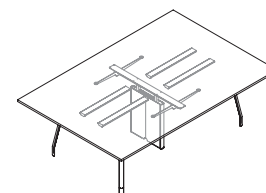
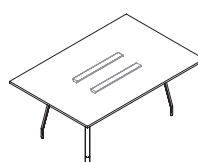
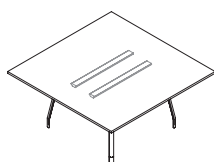

Q MEETING TABLES

**Square tables
composed of n.1 table top,
n.4 legs in BA o NA (G DB GA S F)**

Table top code (G DL PI 120 Q)
120×120×H73,4 cm
G M M 120 Q ..

Table top code (G DL PI 140 Q)
140×140×H73,4 cm
G M M 120 Q ..

Table top code (G DL PI 160 Q)
160×160×H73,4 cm
G M M 160 Q ..

Table top code (G DL PI 180 Q)
180×180×H73,4 cm
G M M 180 Q ..

**Rectangular tables
composed of n.1 table top,
n.4 gambe in BA o NA (G DB GA S F)**

Table top code (G DL PI 180 12 Q)
180×120×H73,4 cm
G M M 180 120 Q ..

**Rectangular tables composed of
n.1 table top, n.4 legs in BA o NA
(G DB GA S F), n.1 central leg/cables
riser (G DB GD F)**

Table top code (G DL PI 240 12 Q)
240×120×H73,4 cm
G M M 240 120 Q ..

Table top code (G DL PI 240 12 Q)
240×160×H73,4 cm
G M M 240 160 Q ..

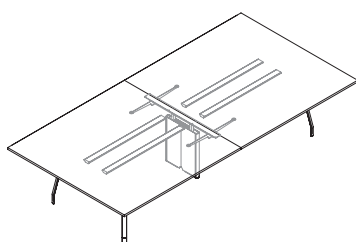

**Rectangular tables composed of n.2 piani,
n.4 legs in BA o NA (G DB GA S F),
n.1 central leg/cables riser (G DB GD F)**

Table top code (G DL PI 280 14 Q)
280×140×H73,4 cm
G M M 280 140 Q ..

Table top code (G DL PI 320 16 Q)
320×160×H73,4 cm
G M M 320 160 Q ..

Table top code (G DL PI 360 18 Q)
360×180×H73,4 cm
G M M 360 180 Q ..

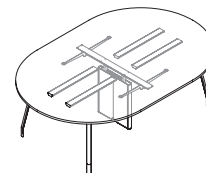

R-S MEETING TABLES

**Round tables
composed of n.1 table top,
n.4 legs in BA o NA (G DB GA S F)**

Table top code (G DL PI 090 R)
90×90×H73,4 cm
G M M 090 R ..

Table top code (G DL PI 120 R)
120×120×H73,4 cm
G M M 120 R ..

Table top code (G DL PI 140 R)
140×140×H73,4 cm
G M M 140 R ..

Table top code (G DL PI 160 R)
160×160×H73,4 cm
G M M 160 R ..

Table top code (G DL PI 180 R)
180×180×H73,4 cm
G M M 180 R ..

**Oval table
composed of n.1 table top,
n.4 legs in BA o NA (G DB GA S F)**

Table top code (G DL PI 180 12 Q)
180×120×H73,4 cm
G M M 180 120 S ..

**Oval tables composed of
n.1 table top, n.4 legs in BA o NA
(G DB GA S F), n.1 central leg/cables
riser (G DB GD F)**

Table top code (G DL PI 240 12 S)
240×120×H73,4 cm
G M M 240 120 S ..

Table top code (G DL PI 240 12 S)
240×160×H73,4 cm
G M M 240 160 S ..

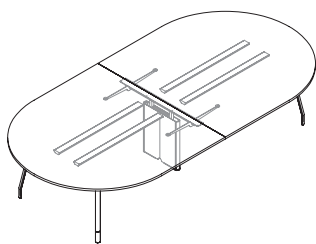

**Oval tables composed of n.2 table tops,
n.4 legs in BA o NA (G DB GA S F),
n.1 central leg/cables riser (G DB GD F)**

Table top code (G DL PI 280 14 S)
280×140×H73,4 cm
G M M 280 140 S ..

Table top code (G DL PI 320 16 Q)
320×160×H73,4 cm
G M M 320 160 S ..

Table top code (G DL PI 360 18 Q)
360×180×H73,4 cm
G M M 360 180 S ..

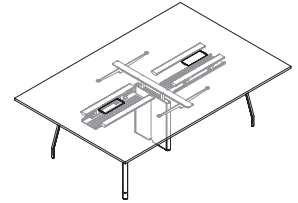
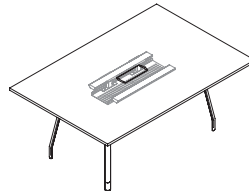
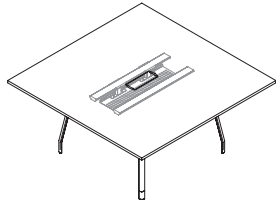

**Q MEETING TABLES, PRE-ARRANGED
FOR ELECTRIFICATION**

**Squared tables
composed of n.1 table top,
n.4 legs in BA o NA (G DB GA S F),
n.1 flip access door (P D P CAB Z11),
n.1 cable tray (G DL WB 75)**

Table top code (G DL PI 140 Q W)
140x140xH73,4 cm
G M M 140 Q W ..

Table top code (G DL PI 160 Q W)
160x160xH73,4 cm
G M M 160 Q W ..

Table top code (G DL PI 180 Q W)
180x180xH73,4 cm
G M M 180 Q W ..

**Rectangular table
composed of n.1 table top,
n.4 legs in BA o NA (G DB GA S F),
n.1 flip access door (P D P CAB Z11),
n.1 cable tray (G DL WB 75)**

Table top code (G DL PI 180 12 Q W)
180x120xH73,4 cm
G M M 180 120 Q W ..

**Rectangular tables
composed of n.1 table top,
n.4 legs in BA o NA (G DB GA S F),
n.1 central leg/cables riser
(G DB GD F),
n.2 flip access doors (P D P CAB Z11),
n.2 cable trays (G DL WB 75)**

Table top code (G DL PI 240 12 Q W)
240x120xH73,4 cm
G M M 240 120 Q W ..

Table top code (G DL PI 240 12 Q W)
240x160xH73,4 cm
G M M 240 160 Q W ..

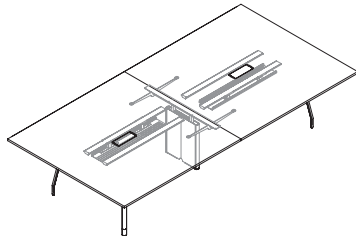

**Rectangular tables
composed of n.1 table top,
n.4 legs in BA o NA (G DB GA S F),
n.1 central leg/cables riser
(G DB GD F),
n.2 flip access doors (P D P CAB Z11),
n.2 cable trays (G DL WB 100)**

Table top code (G DL PI 280 14 Q W)
280x140xH73,4 cm
G M M 280 140 Q W ..

Table top code (G DL PI 320 16 Q W)
320x160xH73,4 cm
G M M 320 160 Q W ..

Table top code (G DL PI 360 18 Q W)
360x180xH73,4 cm
G M M 360 180 Q W ..

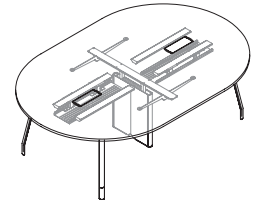
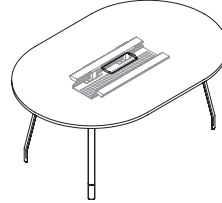
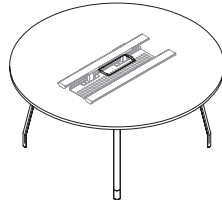

**R-S MEETING TABLES,
PRE-ARRANGED FOR
ELECTRIFICATION**

Round tables composed of n.1 table top, n.4 legs in BA o NA (G DB GA S F), n.1 flip access door (P D P CAB Z11), n.1 cable tray (G DL WB 75)

Table top code (G DL PI 140 R W)
140x140xH73,4 cm
G M M 140 R W ..

Table top code (G DL PI 160 R W)
160x160xH73,4 cm
G M M 160 R W ..

Table top code (G DL PI 180 R W)
180x180xH73,4 cm
G M M 180 R W ..

Oval table composed of n.1 table top, n.4 legs in BA o NA (G DB GA S F), n.1 flip access door (P D P CAB Z11), n.1 cable tray (G DL WB 75)

Table top code (G DL PI 180 12 S W)
180x120xH73,4 cm
G M M 180 120 S W ..

Oval tables composed of n.1 table top, n.4 legs in BA o NA (G DB GA S F), n.1 central leg/cables riser (G DB GD S F), n.2 flip access doors (P D P CAB Z11), n.2 cable trays (G DL WB 75)

Table top code (G DL PI 240 12 S W)
240x120xH73,4 cm
G M M 240 120 S W ..

Table top code (G DL PI 240 16 S W)
240x160xH73,4 cm
G M M 240 160 S W ..

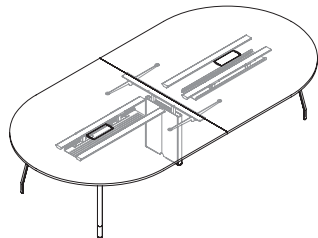

Oval table composed of n.1 table top, n.4 legs in BA o NA (G DB GA S F), n.1 central leg/cables riser (G DB GD F), n.2 flip access doors (P D P CAB Z11), n.2 cable trays (G DL WB 100)

Table top code (G DL PI 280 14 S W)
280x140xH73,4 cm
G M M 280 140 S W ..

Table top code (G DL PI 320 16 S W)
320x160xH73,4 cm
G M M 320 160 S W ..

Table top code (G DL PI 360 18 S W)
360x180xH73,4 cm
G M M 360 180 S W .

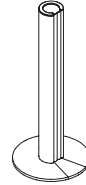

CABLES RISER

Flexible cables riser with side zipper
Only black

7x1xH67 cm
I A SCF ET ..

Flexible cables riser
Only transparent

13x13xH60 cm
I A SCF B ..

Round cables riser

25x25xH43,5 cm
I A SC Z02 ..

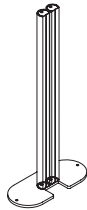

Cables riser

27,8x12xH53,5 cm
Y NO A SC Z01 ..

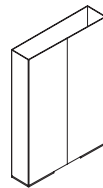

Cables riser cover

Only Chrome painted (3C)

34,8x8xH55,4 cm
Y NO A SC Z01 ..

TABLE TOPS AND COMBINATIONS
TABLE TOPS/STRUCTURES FINISHES

(Structure in: BA- NA)

Laminate



I4
White compact laminate



IG
Platinum Grey compact laminate



IS
Sycamore compact laminate



IY
Natural Oak compact laminate

Standard natural veneer
(certified genuine wood
from Europe - Canada - USA)



AS
Sycamore



RV
Natural Oak



NK
Canaletto Walnut
straight-grained

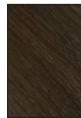

5R
Thermo-treated Oak

For combinations of table tops/structure,
it is necessary to specify when ordering
the finish of the structure

LEGS AND STRUCTURES FINISHES

Epoxy powder coating



D7
Charcoal painting



T0
Ash painting



VP
Platinum Grey painting



C7
Calce White painting



KS
Soft black painting

Galvanic treatment



BA
Polished aluminum



NA
Natural aluminum

For other finishes,
please contact our Sales Department

**ELECTRIFICATION, ACCESSORIES,
CABLES RISERS**

Epoxy powder coating



D7
Charcoal painting



T0
Ash painting



VP
Platinum Grey painting



C7
Calce White painting



KS
Soft black painting

HANGING SCREENS FINISHES

Laminato

Profiles in: D7-T0-VP- C7- KS



S4
White laminate



GP
Platinum Grey laminate



LS
Sycamore laminate



RY
Natural Oak laminate

Fabric

Profiles in: D7-T0-VP- C7- KS



J2
COM fabric

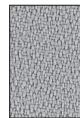

J3
Mirage fabric



Q0
Revive 1 fabric



Q1
Chip fabric



Q2
File fabric

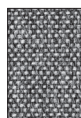

K3
Remix 3 fabric



K4
Sole fabric

Glass

Polycarbonate profiles



CS
Frosted glass

It is necessary to specify when ordering
the finish of the structure

For other finishes,
please contact our Sales Department



ISO 9001



ISO 14001

UniFor has management system certified according to UNI EN ISO 9001 and UNI EN ISO 14001. The products are in conformance with the Italian decree law DLGS 81:2008 and with all of the principal regulations applicable to the various types of products.

The products described in this catalog are made with class E1 materials (low formaldehyde content) and are Greenguard® certified.