

TDS
Technical Data Sheet

Release Date
10 2023



This range of furnishings was created to provide sophisticated, practical solutions for executive workspaces, individual offices, meeting rooms, and prestigious corporate spaces.

The Mood series consists of desks in various shapes and sizes, carefully designed in every detail, as well as drawer pedestals, cabinets, and bookcases.

Tables

The tables are supported by a single steel structural column with a disk base and chrome-plated finish. The tops feature a natural wood finish and careful detailing, including rounded corners and bevelled edges in solid wood.

They are available in various sizes and shapes, including round, square, elliptical, rectangular, and with the shorter sides as semicircles. The base with a central column varies according to the size of the top.

The cable management system consists of the column serving as the cable riser, cables trays mounted below the top, and access hatches mounted flush with the top, positioned either to one side, at the centre, or in a symmetrical pair with respect to the base.

Containers

The containers of the Moodway series consist of low cabinets and bookcases characterised by minimalist forms and smooth wood finishes. They are available in open versions or with folding doors.

EDGE

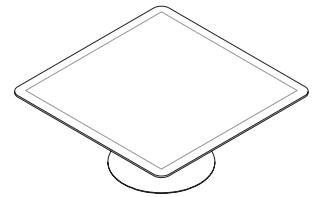
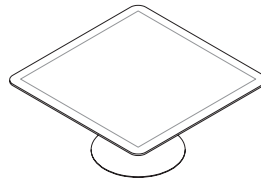
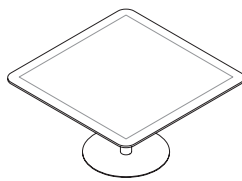
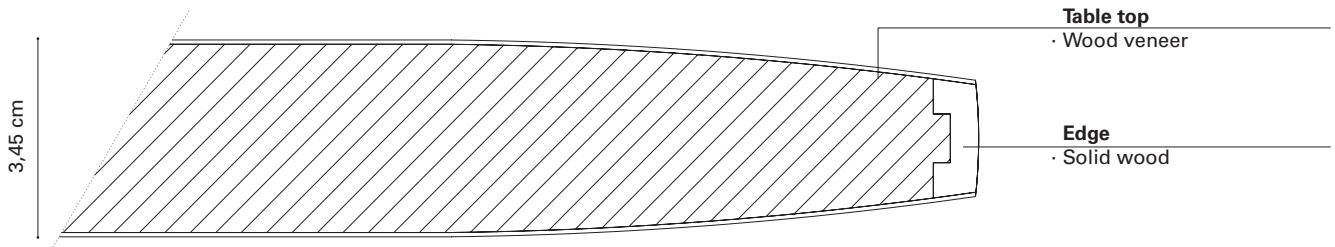

SQUARED TABLES

Squared tables composed of n.1 table top (Q MW 140 Q) and n.1 leg (QR 070 R)

140×140×H73 cm
Q WM 140 Q ..

Squared tables composed of C n.1 table top (Q MW 160 Q) and n.1 leg (QR 080 R)

160×160×H73 cm
Q WM 160 Q ..

Squared tables composed of n.1 table top (Q MW 180 Q) and n.1 leg (QR 085 R)

180×180×H3 cm
Q WM 180 Q

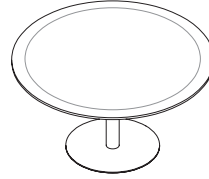
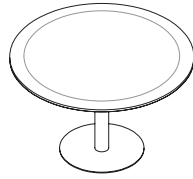

ROUND TABLES

**Round tables composed of
n.1 table top (Q MW 120 R)
and n.1 leg (QR 055 R)**

120x120xH73 cm
Q WM 120 R ..

**Round tables composed of
n.1 table top (Q MW 140 R)
and n.1 leg (QR 065 R)**

140x140xH73 cm
Q WM 140 R ..

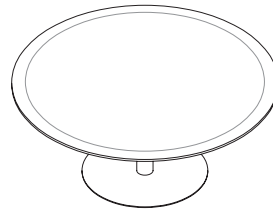
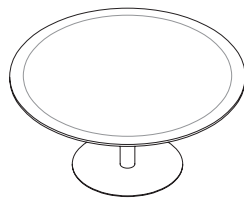

**Round tables composed of
n.1 table top (Q MW 160 R)
and n.1 leg (QR 075 R)**

160x160xH73 cm
Q DM 160 R ..

**Round tables composed of
n.1 table top (Q MW 180 R)
and n.1 leg (QR 085 R)**

180x180xH73 cm
Q DM 180 R ..

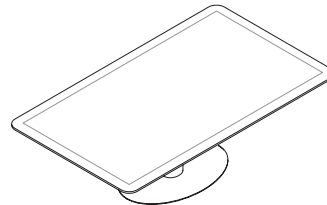
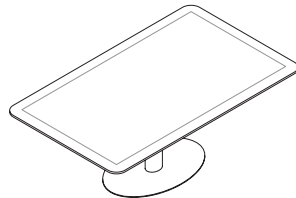

RECTANGULAR TABLES

**Rectangular tables composed of
n.1 table top (Q MW 200 120 Q)
and n.1 leg (QR 090 060 Q)**

200x120xH73 cm
Q WM 200 120 Q ..

**Rectangular tables composed of
n.1 table top (Q MW 240 140 Q)
and n.1 leg (QR 105 070 Q)**

240x140xH73 cm
Q WM 240 140 Q ..

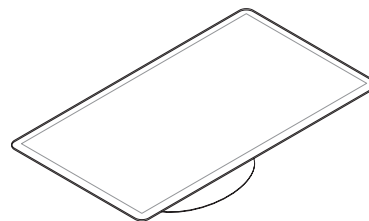
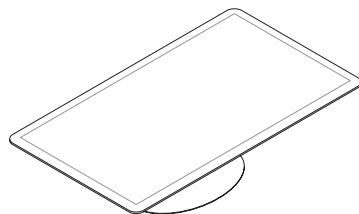

**Rectangular tables composed of
n.1 table top (Q MW 280 160 Q)
and n.1 leg (QR 120 080 Q)**

280x160xH73 cm
Q WM 280 160 Q ..

**Rectangular tables composed of
n.1 table top (Q MW 320 180 Q)
and n.1 leg (QR 135 090 Q)**

180x180xH73 cm
Q DM 180 R ..

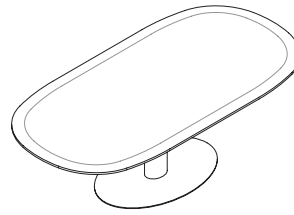
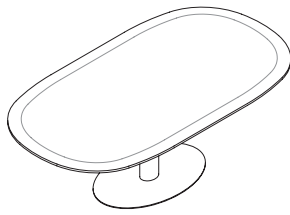

D-END TABLES

**D-end tables, composed of
n.1 table top (Q MW 220 120 B)
and n.1 leg (QR 090 060)**

220x120xH73 cm
Q WM 220 120 B ..

**D-end tables, composed of
n.1 table top (Q MW 240 120 B)
and n.1 leg (QR 105 070)**

240x120xH73 cm
Q WM 240 120 B ..

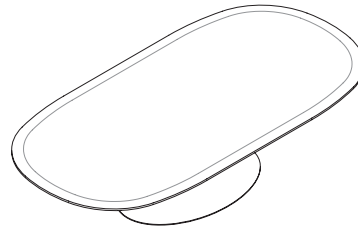
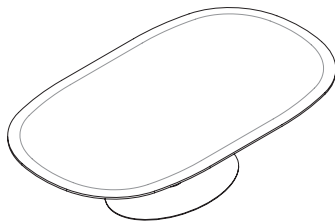

**D-end tables, composed of
n.1 table top (Q MW 280 160 B)
and n.1 leg (QR 120 080)**

280x160xH73 cm
Q WM 280 160 B ..

**D-end tables, composed of
n.1 table top (Q MW 320 180 B)
and n.1 leg (QR 135 090)**

320x180xH73 cm
Q WM 320 180 B ..

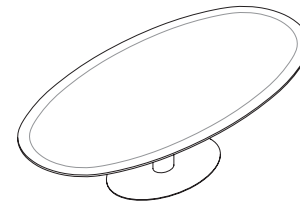
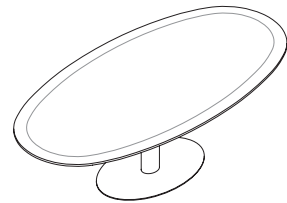

ELLIPTICAL TABLES

**Elliptical tables composed of
n.1 table top (Q MW 240 120 S)
and n.1 leg (QR 090 060)**

240x120xH73 cm
Q WM 240 120 S ..

**Elliptical tables composed of
n.1 table top (Q MW 280 140 S)
and n.1 leg (QR 105 070)**

240x140xH73 cm
Q WM 280 140 S ..

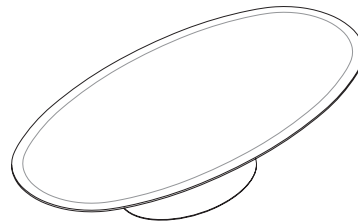
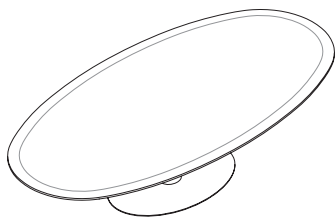

**Elliptical tables, composed of
n.1 table top (Q MW 320 160 S)
and n.1 leg (QR 120 080)**

280x160xH73 cm
Q WM 320 160 S ..

**Elliptical tables, composed of
n.1 table top (Q MW 360 180 S)
and n.1 leg (QR 135 090)**

180x180xH73 cm
Q WM 360 180 S ..

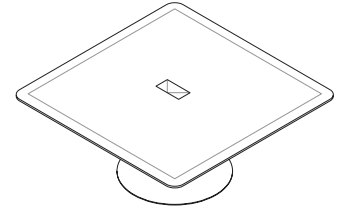
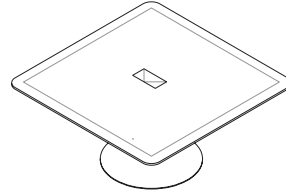
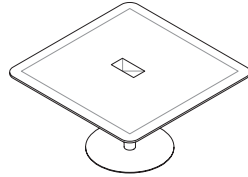

SQUARED TABLES
PRE-ARRANGED
FOR ELECTRIFICATION

**Squared tables composed of
n.1 table top (Q MW 140 Q W),
n.1 leg (QR 070 R W),
n.1 flip access door (P DP CAB Z31)**

140x140xH73 cm
Q WM 140 Q W ..

**Squared tables composed of
n.1 table top (Q MW 160 Q W),
n.1 leg (QR 080 R W),
n.1 flip access door (P DP CAB Z31)**

160x160xH73 cm
Q WM 160 Q W ..

**Squared tables composed of
n.1 table top (Q MW 180 Q W)
n.1 leg (QR 085 R W),
n.1 flip access door (P DP CAB Z31)**

180x180xH73 cm
Q WM 180 Q W ..

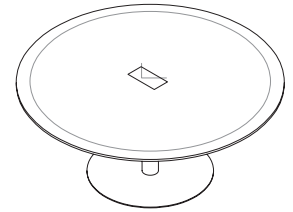
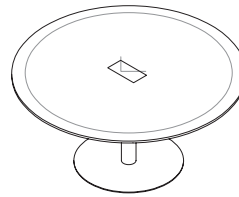
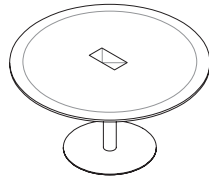

ROUND TABLES
PRE-ARRANGED
FOR ELECTRIFICATION

**Round tables composed of
n.1 table top (Q MW 140 R W),
n.1 leg (QR 065 R W),
n.1 flip access door (P DP CAB Z31)**

140x140xH73 cm
Q WM 140 R W ..

**Round tables composed of
n.1 table top (Q MW 160 R W),
n.1 leg (QR 075 R W),
n.1 flip access door (P DP CAB Z31)**

160x160xH73 cm
Q WM 160 R W ..

**Round tables composed of
n.1 table top (Q MW 180 R W),
n.1 leg (QR 085 R W),
n.1 flip access door (P DP CAB Z31)**

180x180xH73 cm
Q WM 180 R W ..

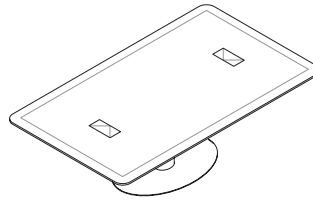
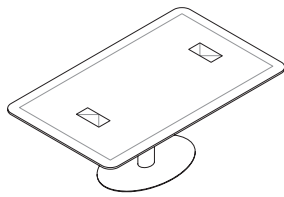

RECTANGULAR TABLES
PRE-ARRANGED
FOR ELECTRIFICATION

Rectangular tables composed of
n.1 table top (Q MW 200 120 Q W),
n.1 leg (QR 090 060 Q W),
n.2 flip access doors (P DP CAB Z31)

200x120xH73 cm
Q WM 200 120 Q W ..

Rectangular tables composed of
n.1 table top (Q MW 240 140 Q W),
n.1 leg (QR 105 070 Q W),
n.2 flip access doors (P DP CAB Z31)

240x140xH73 cm
Q WM 240 140 Q W ..

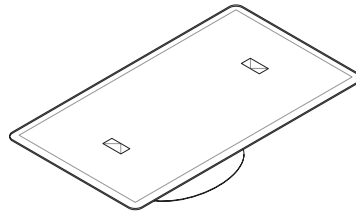
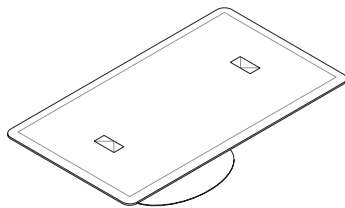

Rectangular tables composed of
n.1 table top (Q MW 280 160 Q W),
n.1 leg (QR 120 080 Q W),
n.2 flip access doors (P DP CAB Z31)

280x160xH73 cm
Q WM 280 160 Q W ..

Rectangular tables composed of
n.1 table top (Q MW 320 180 Q W),
n.1 leg (QR 135 090 Q W),
n.2 flip access doors (P DP CAB Z31)

320x180xH73 cm
Q WM 320 180 Q W ..

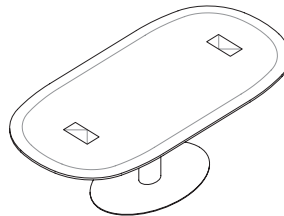
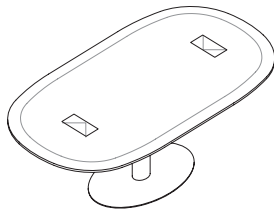

D-END TABLES
PRE-ARRANGED FOR
ELECTRIFICATION

D-end tables, composed of
n.1 table top (Q MW 220 120 B W),
n.1 leg (QR 090 060 W),
n.2 flip access doors (P DP CAB Z31)

220x120xH73 cm
Q WM 220 120 B W ..

D-end tables, composed of
n.1 table top (Q MW 240 120 B W),
n.1 leg (QR 105 070 W),
n.2 flip access doors (P DP CAB Z31)

240x140xH73 cm
Q WM 240 120 B W ..

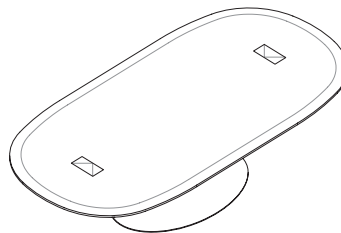
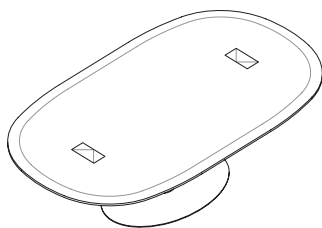

D-end tables, composed of
n.1 table top (Q MW 280 160 B W),
n.1 leg (QR 120 080 W),
n.2 flip access doors (P DP CAB Z31)

280x160xH73 cm
Q WM 280 160 B W ..

D-end tables, composed of
n.1 table top (Q MW 320 180 B W),
n.1 leg (QR 135 090 W),
n.2 flip access doors (P DP CAB Z31)

180x180xH73 cm
Q WM 320 180 B W ..

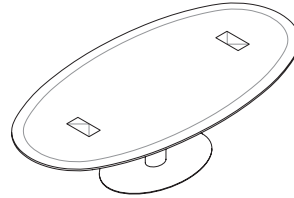
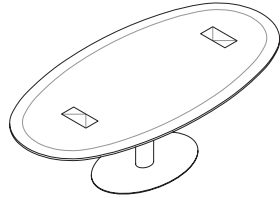

ELLIPTICAL TABLES
PRE-ARRANGED
FOR ELECTRIFICATION

Elliptical tables composed of
n.1 table top (Q MW 240 120 S),
n.1 leg (QR 090 060 W),
n.2 flip access doors (P DP CAB Z31)

240x120xH73 cm
Q WM 240 120 S W ..

Elliptical tables composed of
n.1 table top (Q MW 280 140 SW),
n.1 leg (QR 105 070 W),
n.2 flip access doors (P DP CAB Z31)

280x140xH73 cm
Q WM 280 140 S W ..

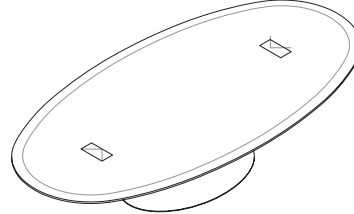
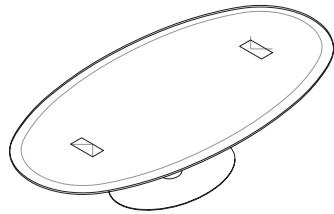

Elliptical tables, composed of
n.1 table top (Q MW 320 160 SW),
n.1 leg (QR 120 080 W),
n.2 flip access doors (P DP CAB Z31)

320x160xH73 cm
Q WM 320 160 S W ..

Elliptical tables, composed of
n.1 table top (Q MW 360 180 SW)
and n.1 leg (QR 135 090 W),
n.2 flip access doors (P DP CAB Z31)

360x180xH73 cm
Q WM 360 180 S W ..

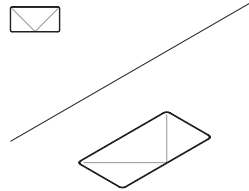

FLIP ACCESS DOOR

Rectangular flip access door
Same as top finish.
Specify the position.

25x12,5xH3,4 cm
P D P CAB Z31 ..

SECTION ROUND AND SQUARED TABLES PRE-ARRANGED FOR ELECTRIFICATION

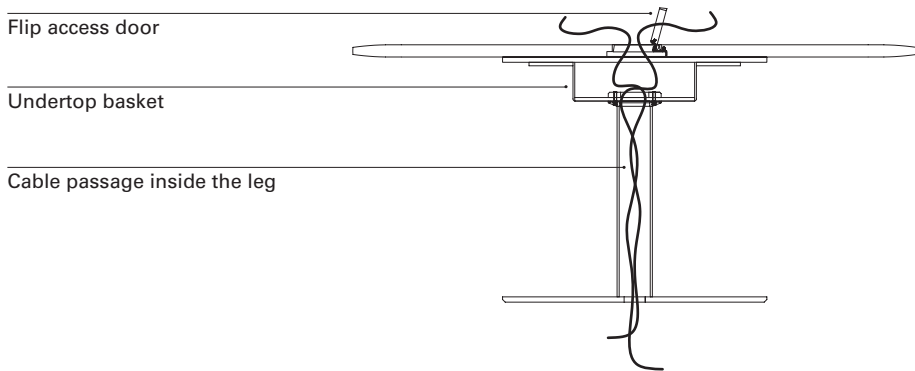

SECTION RECTANGULAR, D-END AND ELLIPTICAL TABLES PRE-ARRANGED FOR ELECTRIFICATION

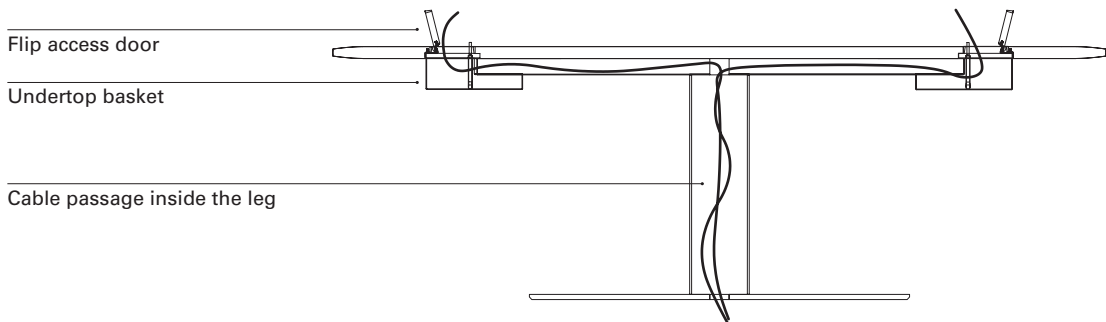

POSITION 1

Top with 2 flip access doors,
standard in price list

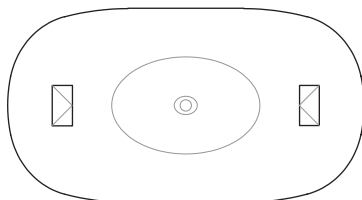

POSITION 2

Top with 1 flip access door,
on request

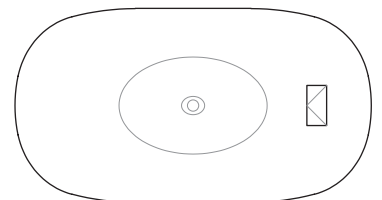

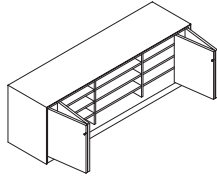

CABINETS

Low cabinet with sliding doors

180x40xH62 cm
Q.MW 180 62 A ..

TABLETOP AND CABINETS FINISHES

Standard natural veneer
(certified genuine wood
from Europe - Canada - USA)

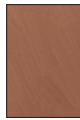

PE
Pearwood



NO
National Walnut

BASES FINISHES

Galvanic treatment



CM
Chromed metal

For other finishes,
please contact our Sales Department



ISO 9001



ISO 14001

UniFor has management system certified according to UNI EN ISO 9001 and UNI EN ISO 14001. The products are in conformance with the Italian decree law DLGS 81:2008 and with all of the principal regulations applicable to the various types of products.

The products described in this catalog are made with class E1 materials (low formaldehyde content) and are Greenguard® certified.